

VAN WEEL KOELTECHNIEK B.V.

Address: Hoofdweg 92
2908 LC - Capelle a/d IJssel
Business: 010 450 30 84
Mobile: 06 518 36 116
E-Mail: aad@vanweelkoeltechniek.nl
Website: vanweelkoeltechniek.nl

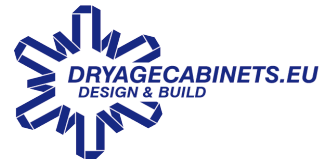

Dry Age Cabinet DAC3DRB

RESUME

TECHNICAL SPECIFICATIONS

- Plug & Play -
- Fully Electronically Controlled DAC System -
- 230 Volt | 1,3 Ampère -
- 250 Watt Power Consumption -
- 320 gr. R134A (Natural Refrigerant) -

EXTRA OPTIONS

- **Free** Custom Logo in your Drip Tray
- Custom Text Formatting, Type & Colour
- Lightfilters
- Meat Racks
- Himalayan Salt Blocks

DIMENSIONS

READINGS

D 500 x **B** 1350 x **H** 900 mm
Advertisement: + **H** 200mm (1.100mm)
Weight: 105,2kg

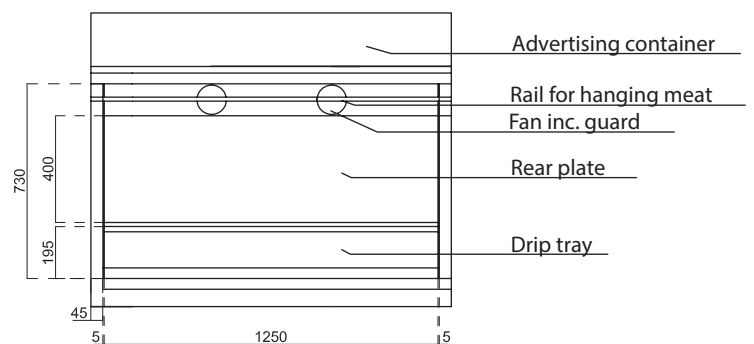
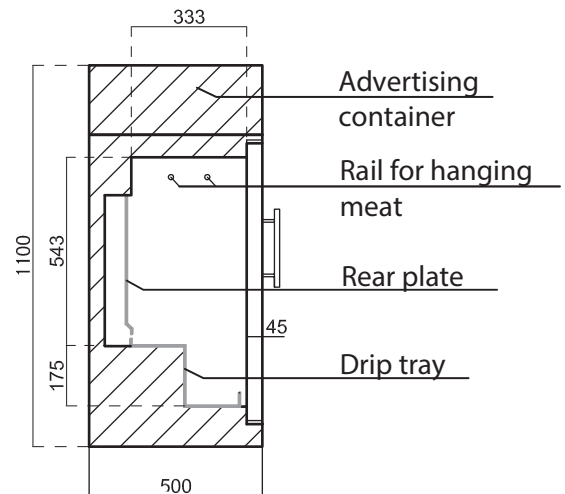
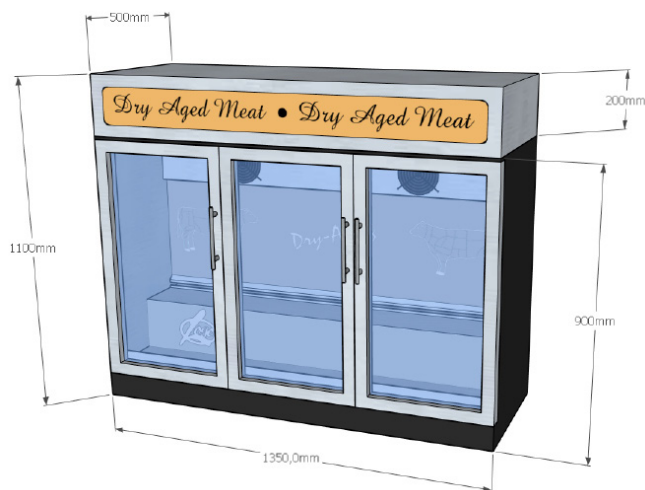

EXAMPLE FONTS

Amazon: *Dry Aged Meat*
Auchen: *Dry Aged Meat*
Dutch: **Dry Aged Meat**

(choosing your own font is also possible)

General Delivery and Payment Conditions following the N.V.K.L., filled in at the District Court of The Hague on May 10, 1994 under No. 74/1994.



VAN WEEL KOELTECHNIEK B.V.

Address: Hoofdweg 92
2908 LC - Capelle a/d IJssel
Business: 010 450 30 84
Mobile: 06 518 36 116
E-Mail: aad@vanweelkoeltechniek.nl
Website: vanweelkoeltechniek.nl

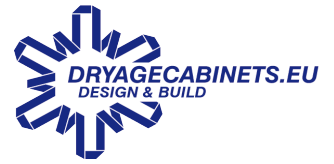

Dry Age Cabinet DAC3DRB

TRANSPORT

DIMENSIONS

D 1420 x **B** 575 x **H** 1310 mm
(+230mm = 1.540mm)
Max. 150kg

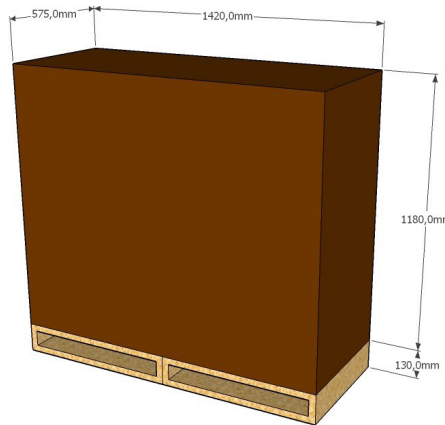

Transport according to terms
and conditions of the transporter

INSTALLATION

PLACEMENT

Take care of the
recommended
space of 60mm / 2,4"
at the back or fitting
outlet at the bottom.

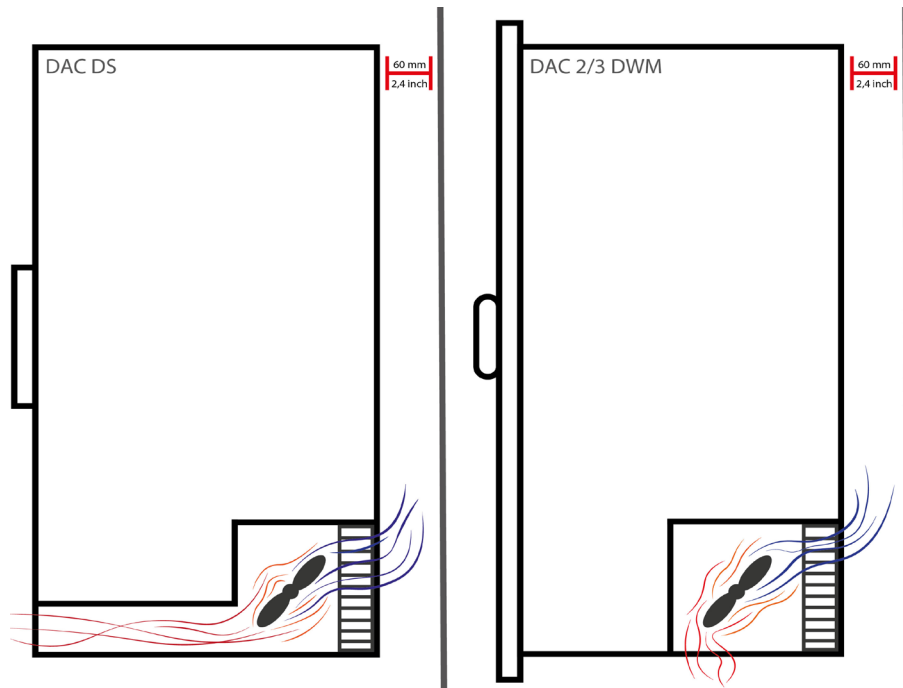

Important
The hole in the
bottom should
agree to come
forward with the
air outlet.

Supplying clean
air through the
backside is
required with
the minimal dis-
tance of 60mm
or 2,4 inch.



CONDENSERS

Not periodically cleaned condensers at
the back of your DAC could result in
irreparable damage.

General Delivery and Payment Conditions following the N.V.K.L., filled in at
the District Court of The Hague on May 10, 1994 under No. 74/1994.

